

JC-300 RDA5807 FM Radio Receiver DIY Kit

1.Introduction:

JC-300 is a 3.7V RDA5807 87MHz-108MHz FM Radio Receiver DIY Kit. It is a simple FM receiver and can be used all over the world with power by 18650 rechargeable battery. It is very suitable for users to learn electronic circuits, practice and proficient soldering skills, and enhance electronic professional knowledge and interest.

2.Feature:

- 1>.Universal frequency 87MHz-108MHz
- 2>.Perfect simple circuit
- 3>.DIY hand soldering
- 4>.Stable fixing bracket
- 5>.Support battery charging function

3.Parameter:

- 1>.Product Name:JC-300 RDA5807 FM Radio Receiver DIY Kit
- 2>.Product Number:JC-300
- 3>.Work Voltage:DC 3.7V
- 4>.Power Type:18650 Battery(Not Included!)
- 6>.Work Temperature:-25℃~85℃
- 7>.Work Humidity:5%~95%RH
- 8>.Size(Installed):170*110*60mm

4.Function:

- 1>.Left two buttons are used to adjust volume.
- 2>.Right two buttons are used to switch FM stations.
- 3>.The switch on the side is the power switch. UP is ON and down is OFF.
- 4>.Power socket is used to charging for 18650 rechargeable battery.

5.Component Listing:

| NO. | Component Name | PCB Marker | Parameter | QTY |
|-----|------------------------|-----------------|------------|-----|
| 1 | Metal Film Resistor | R7,R8,R9 | 0ohm | 3 |
| 2 | Metal Film Resistor | R5,R6 | 2.2ohm | 2 |
| 3 | Metal Film Resistor | R2 | 22ohm | 1 |
| 4 | Metal Film Resistor | R1,R3,R4 | 10Kohm | 3 |
| 5 | Metal Film Resistor | R10 | 2Kohm | 1 |
| 6 | Zener Diode | Z1 3V | DO-35 | 1 |
| 7 | 1N4007 Diode | D1 | DO-41 | 1 |
| 8 | Inductor | L1 | 0.1uH | 1 |
| 9 | Inductor | L2,L3 | 1uH | 2 |
| 10 | RDA5807 FM Receiver | U1 | SOP-16 | 1 |
| 11 | Crystal Oscillator | Y | 32.768KHz | 1 |
| 12 | IC Socket | U2 | DIP-8 | 1 |
| 13 | TDA2822 Amplifier | U2 | DIP-8 | 1 |
| 14 | Ceramic Capacitor | C2 | 27pF | 1 |
| 15 | Ceramic Capacitor | C1,C8 | 0.01uF 103 | 2 |
| 16 | Ceramic Capacitor | C7 | 2.2nF 222 | 1 |
| 17 | Ceramic Capacitor | C3 | 22nF 223 | 1 |
| 18 | Red LED | LED1,LED2 | 3mm | 2 |
| 19 | Electrolytic Capacitor | C6,C9 | 10uF | 2 |
| 20 | Electrolytic Capacitor | C4,C5,C15 | 100uF | 3 |
| 21 | CBB Capacitor | C10,C11,C13,C14 | 0.1uF 104 | 4 |
| 22 | Electrolytic Capacitor | C12 | 2200uF | 1 |
| 23 | Power Socket | J1 | 2.5mm | 1 |
| 24 | Power Switch | K1 | | 1 |
| 25 | Black Button | S1-S4 | | 4 |
| 26 | Speaker | | D:66mm | 1 |

| | | | | |
|----|-------------------|--|--------------|---|
| 27 | Black/Red Wire | | 10cm | 1 |
| 28 | 18650 Battery Box | | | 1 |
| 29 | USB Power Wire | | 80cm | 1 |
| 30 | FM Antenna | | 75ohm | 1 |
| 31 | M3*6mm Screw | | | 2 |
| 32 | M3 Nut | | | 1 |
| 33 | M2*10mm Screw | | | 4 |
| 34 | M2 Nut | | | 4 |
| 35 | Main PCB | | 160*80*1.6mm | 1 |
| 36 | PCB Bracket | | 60*33*1.6mm | 2 |

Note:Users can complete the installation according to the PCB silk screen and component list.

6.Schematic diagram:

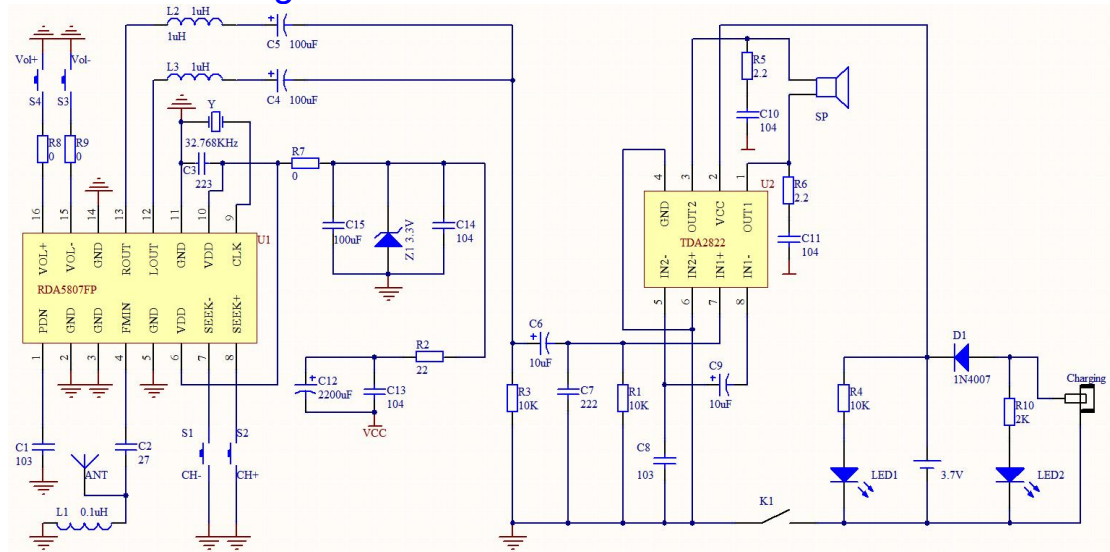

7.Application:

- 1>.Training soldering skills
- 2>.Student school
- 3>.DIY production
- 4>.Project Design
- 5>.Electronic competition
- 6>.Gift giving
- 7>.Crafts collection
- 8>.Home decoration
- 9>.Souvenir collection
- 10>.Graduation design
- 11>.Holiday gifts

8.Installation Tips:

- 1>.User needs to prepare the soldering tool at first:
 - 1.1>.Small Phillips screwdriver
 - 1.2>.Small wire cutters
 - 1.3>.Fine tip soldering iron(Recommend using a fine point soldering tip)
 - 1.4>.Good quality small gauge solder(recommend no larger than 1.0 mm)
 - 1.5>.Magnifying glass
 - 1.6>.1pcs 18650 battery
- 2>.Please be patient until the installation is complete.
- 3>.The package is DIY kit.It need finish install by user.
- 4>.The soldering iron can't touch the components for a long time(1.0 second), otherwise it will damage the components.
- 5>.It is recommend building the project starting with the lowest components first and working up to the highest components. This is a common practice as it makes it easier to hold the low components on the board while soldering

- 6>.Pay attention to the positive and negative of the components.
- 7>.Strictly prohibit short circuit.
- 8>.User must install the LED according to the specified rules.Otherwise some LED will not light.
- 9>.Install complex components preferentially.
- 10>.Make sure all components are in right direction and right place.
- 11>.Check that all of the LED can be illuminated.
- 12>.It is strongly recommended to read the installation manual before installation!!!
- 13>.Please wear anti-static gloves or anti-static wristbands when installing electronic components.

9.Installation Steps(Please be patient install!!!):

- 1>.Step 1: Install 3pcs 0ohm Metal Film Resistor at R7,R8,R9.
- 2>.Step 2: Install 2pcs 2.2ohm Metal Film Resistor at R5,R6.
- 3>.Step 3: Install 1pcs 22ohm Metal Film Resistor at R2.
- 4>.Step 4: Install 3pcs 10Kohm Metal Film Resistor at R1,R3,R4.
- 5>.Step 5: Install 1pcs 2Kohm Metal Film Resistor at R10.
- 6>.Step 6: Install 1pcs DO-35 Zener Diode at Z1 3V. Pay attention to the installation direction. Note: The black mark on Diode and the white mark on PCB are corresponding.
- 7>.Step 7: Install 1pcs DO-41 1N4007 Diode at D1. Pay attention to the installation direction. Note: The white mark on Diode and the white mark on PCB are corresponding.
- 8>.Step 8: Install 1pcs 0.1uH Inductor at L1.
- 9>.Step 9: Install 2pcs 1uH Inductor at L2,L3.
- 10>.Step 10: Install 1pcs SOP-16 RDA5807 FM Receiver at U1 on PCB another side. There is a dot on one end of the IC and there is a dot on PCB where the IC can place on. These two marks are corresponding to each other and are used to specify the installation direction of the IC. Note: 'SMD IC Installation Method' as showing at last if user is not familiar with SMD chip installation
- 11>.Step 11: Install 1pcs 32.768KHz Crystal Oscillator at Y.
- 12>.Step 12: Install 1pcs DIP-8 IC Socket at U2. There is a mark(notch) on one end of the IC Socket and there is a mark(curved silk screen printing) on PCB where the IC Socket can place on. These two marks are corresponding to each other and are used to specify the installation direction of the IC Socket.
- 13>.Step 13: Install 1pcs 27pF Ceramic Capacitor at C2.
- 14>.Step 14: Install 2pcs 0.01uF 103 Ceramic Capacitor at C1,C8.
- 15>.Step 15: Install 1pcs 2.2nF 222 Ceramic Capacitor at C7.
- 16>.Step 16: Install 1pcs 22nF 223 Ceramic Capacitor at C3.
- 17>.Step 17: Install 2pcs 3mm Red LED at LED1,LED2. Pay attention to the installation direction. The shorter pin is negative pole.
- 18>.Step 18: Install 2pcs 10uF Electrolytic Capacitor at C6,C9. Pay attention to distinguish between positive and negative. The shorter pin is negative pole.
- 19>.Step 19: Install 3pcs 100uF Electrolytic Capacitor at C4,C5,C15. Pay attention to distinguish between positive and negative. The shorter pin is negative pole.
- 20>.Step 20: Install 4pcs 0.1uF 104 CBB Capacitor at C10,C11,C13,C14.
- 21>.Step 21: Install 1pcs 2200uF Electrolytic Capacitor at C12. Pay attention to distinguish between positive and negative. The shorter pin is negative pole.
- 22>.Step 22: Install 1pcs Power Socket at J1.
- 23>.Step 23: Install 1pcs Power Switch at K1.
- 24>.Step 24: Install 4pcs Black Button at S1-S4.
- 25>.Step 25: Install 1pcs DIP-8 IC TDA2822 Amplifier at U2. There is a mark(notch) on one end of the IC Socket and there is a mark(curved silk screen printing) on PCB where the IC can place on. These two marks are corresponding to each other and are used to specify the installation direction of the IC.
- 26>.Step 26: Fix Speaker on another side by 4pcs M2*10mm Screw and 4pcs M2 Nut.
- 27>.Step 27: Connect speaker to PCB by red/black wires.
- 28>.Step 28: Fix 18650 battery box by 1pcs M3*6mm Screw and 1pcs M3 Nut. Pay attention to the installation direction.
- 29>.Step 29: Connect battery wire to PCB: Red connect to '+' and black connect to '-'.
- 30>.Step 30: Fix 1pcs FM Antenna by 1pcs M3*6mm Screw.
- 31>.Step 31: Fix 2pcs PCB Bracket. Note that the pads must be aligned.
- 32>.Step 32: Install 1pcs 3.7V 18650 battery(no included) and to receiver FM stations.

10. Install shown steps:

Step 1: Install 3pcs 0ohm Metal Film Resistor at R7,R8,R9.

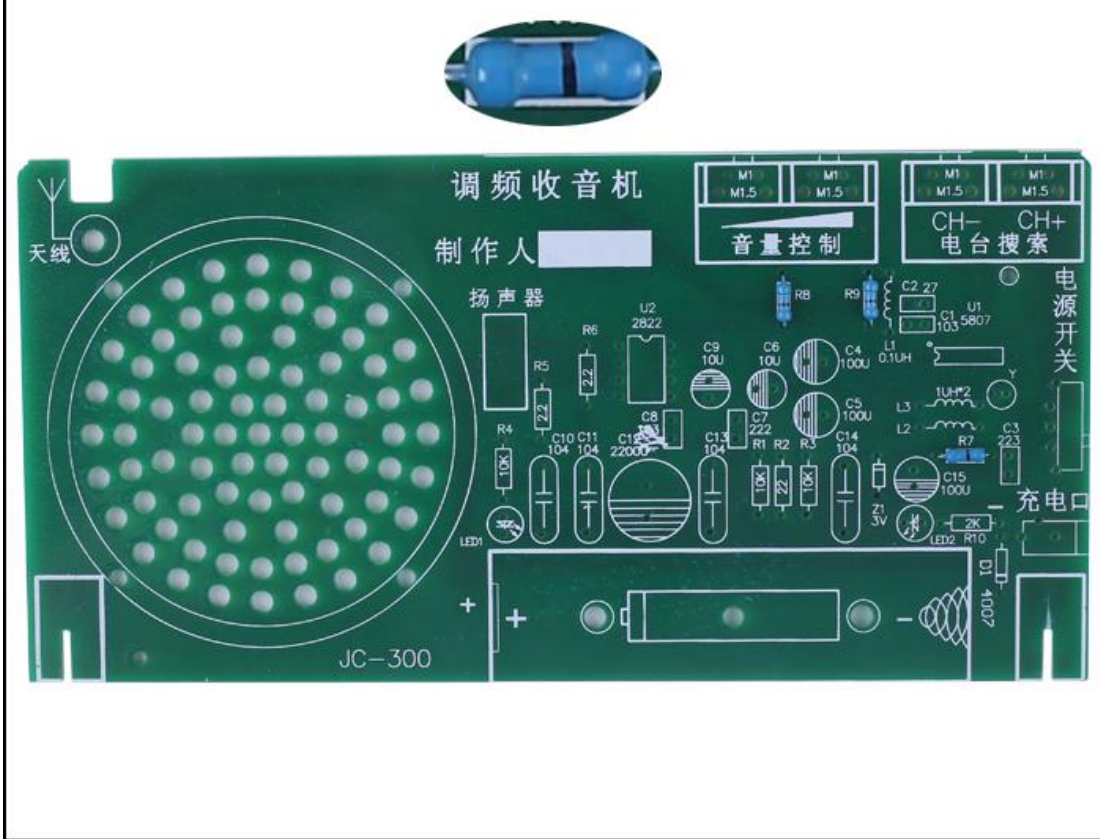

Step 2: Install 2pcs 2.2ohm Metal Film Resistor at R5,R6.

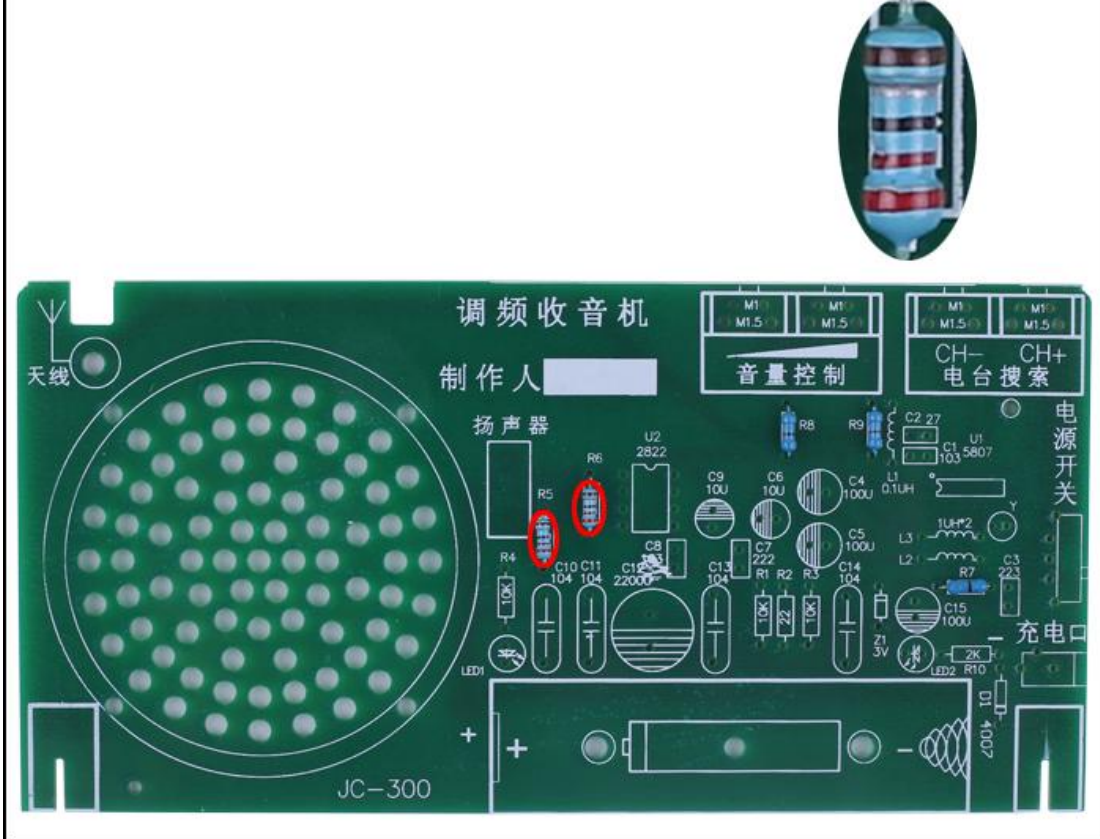

Step 3: Install 1pcs 22ohm Metal Film Resistor at R2.

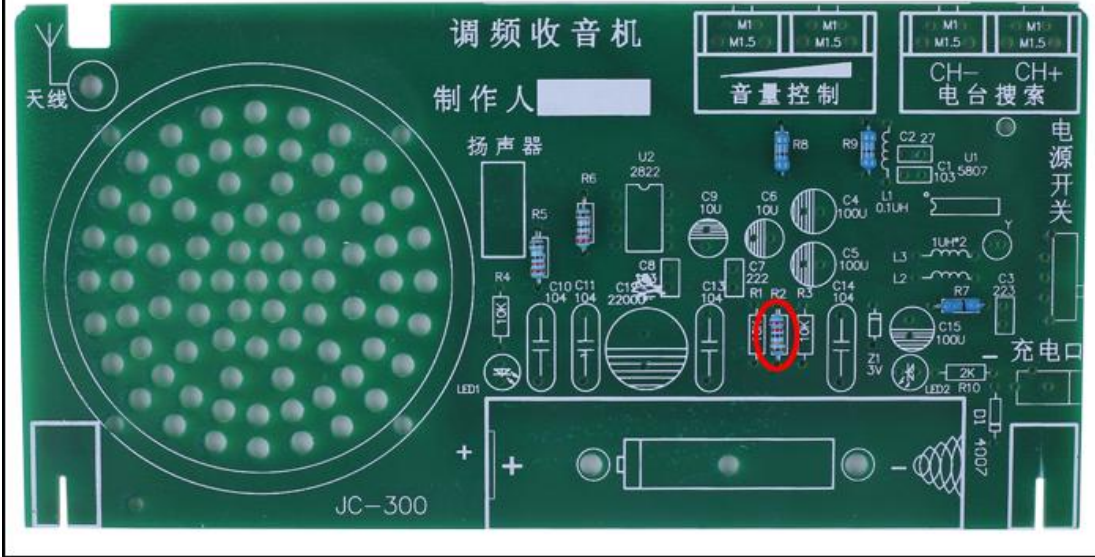

Step 4: Install 3pcs 10Kohm Metal Film Resistor at R1,R3,R4.

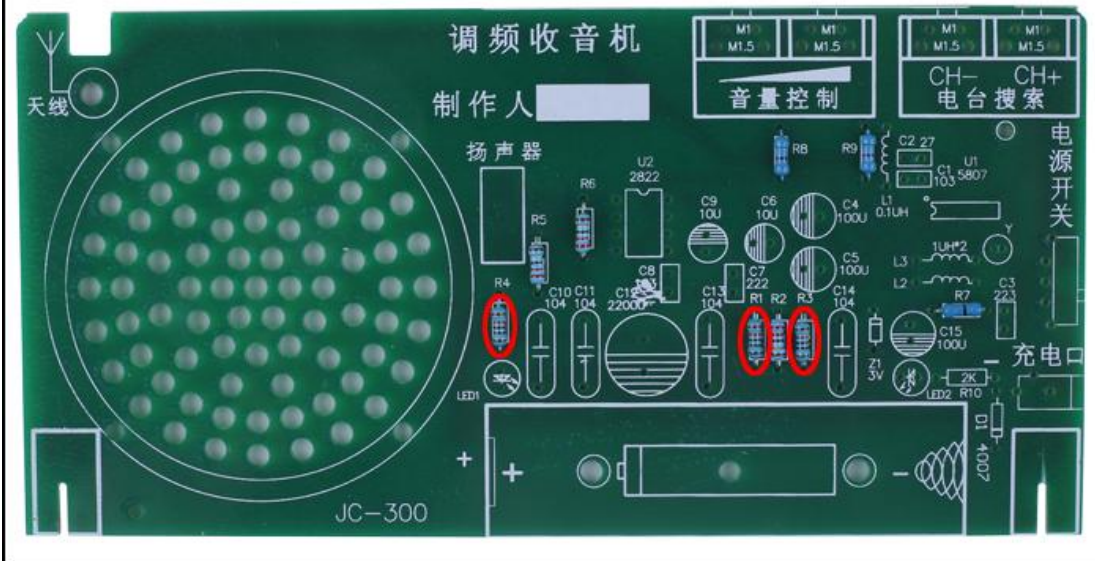

Step 5: Install 1pcs 2Kohm Metal Film Resistor at R10.

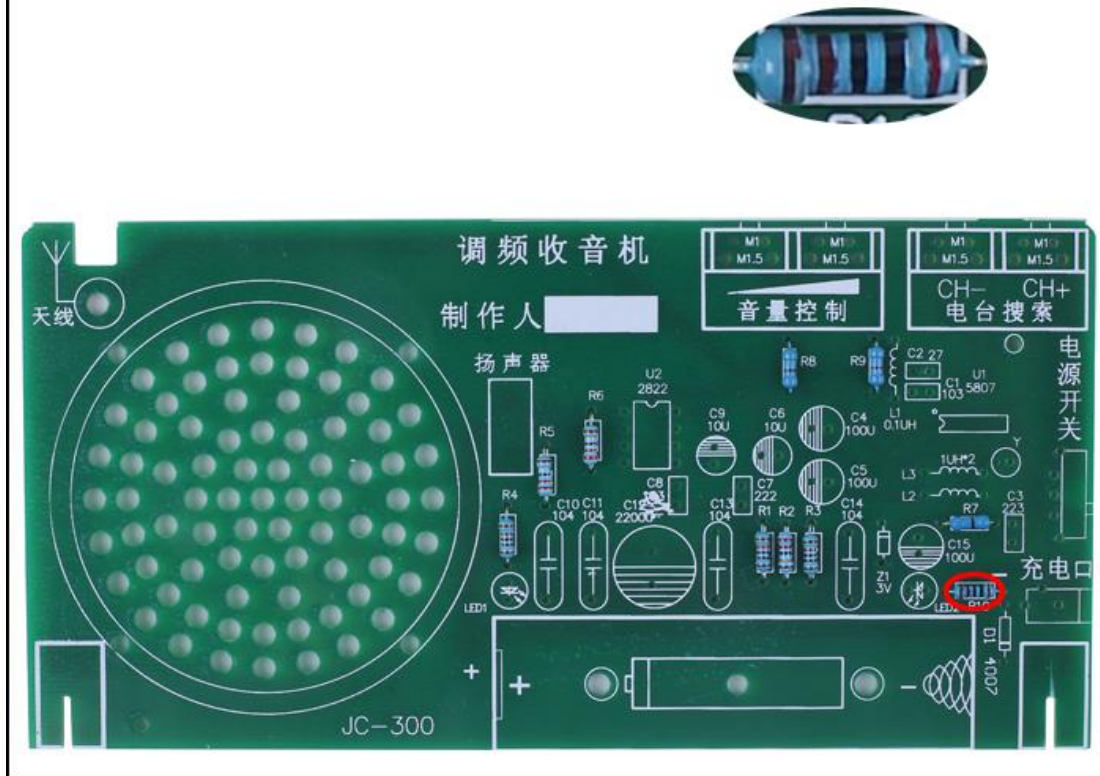

Step 6: Install 1pcs DO-35 Zener Diode at Z1 3V. Pay attention to the installation direction. Note: The black mark on Diode and the white mark on PCB are corresponding.

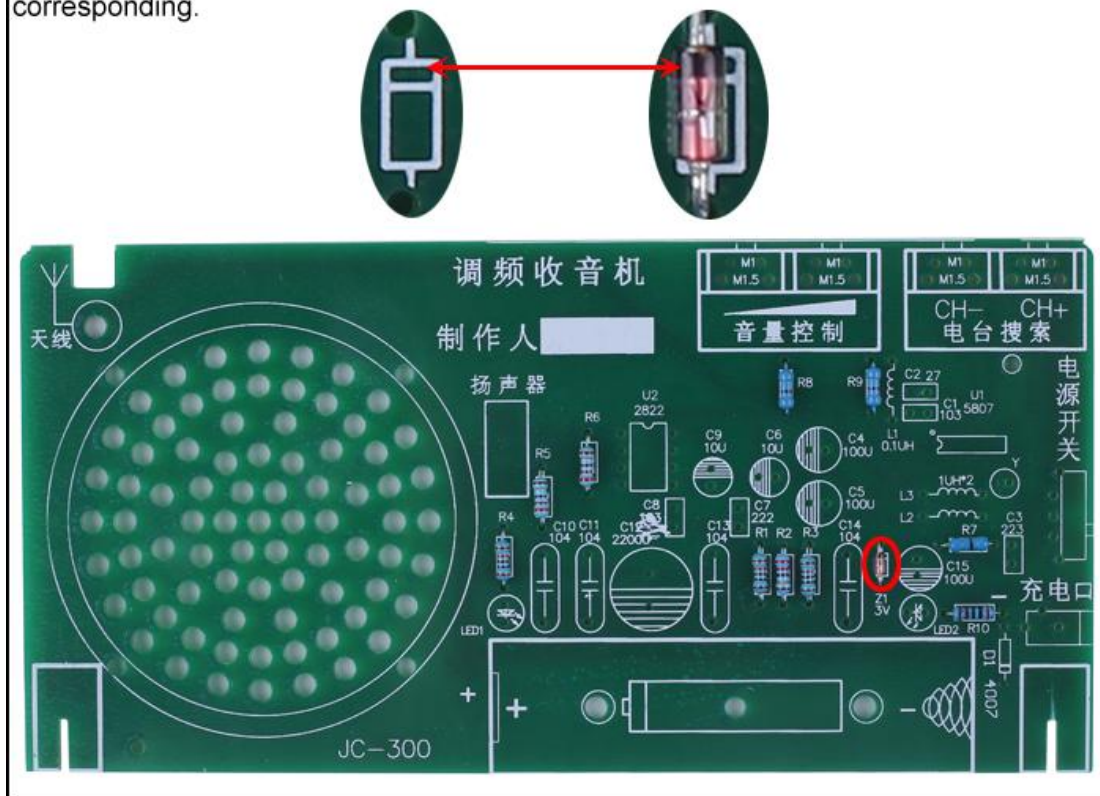

Step 7: Install 1pcs DO-41 1N4007 Diode at D1. Pay attention to the installation direction. Note: The white mark on Diode and white mark on PCB are corresponding.

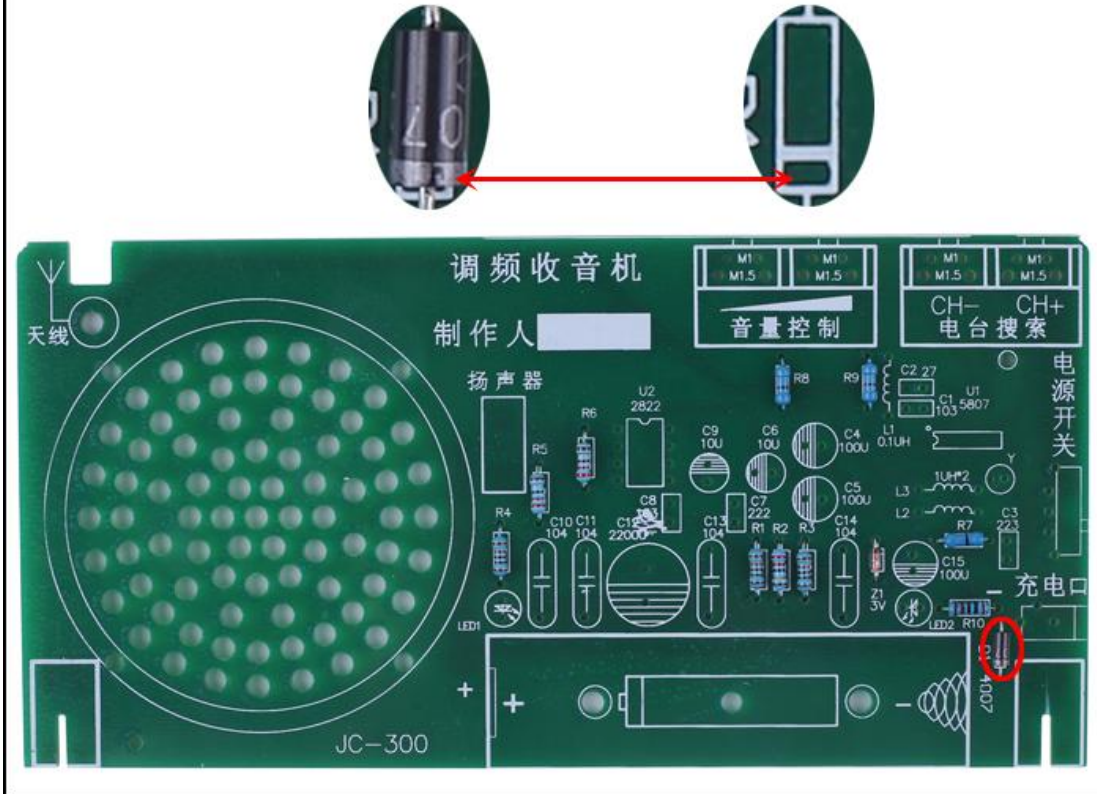

Step 8: Install 1pcs 0.1uH Inductor at L1.

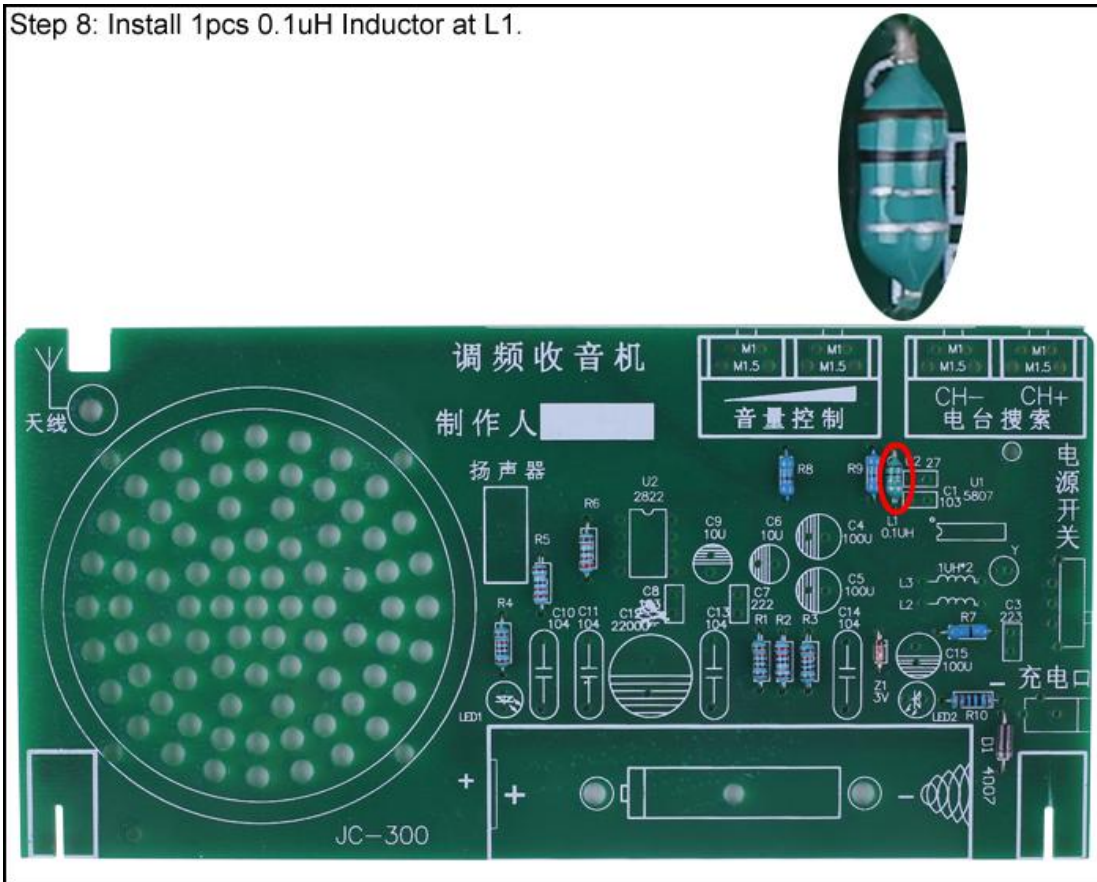

Step 9: Install 2pcs 1uH Inductor at L2,L3.

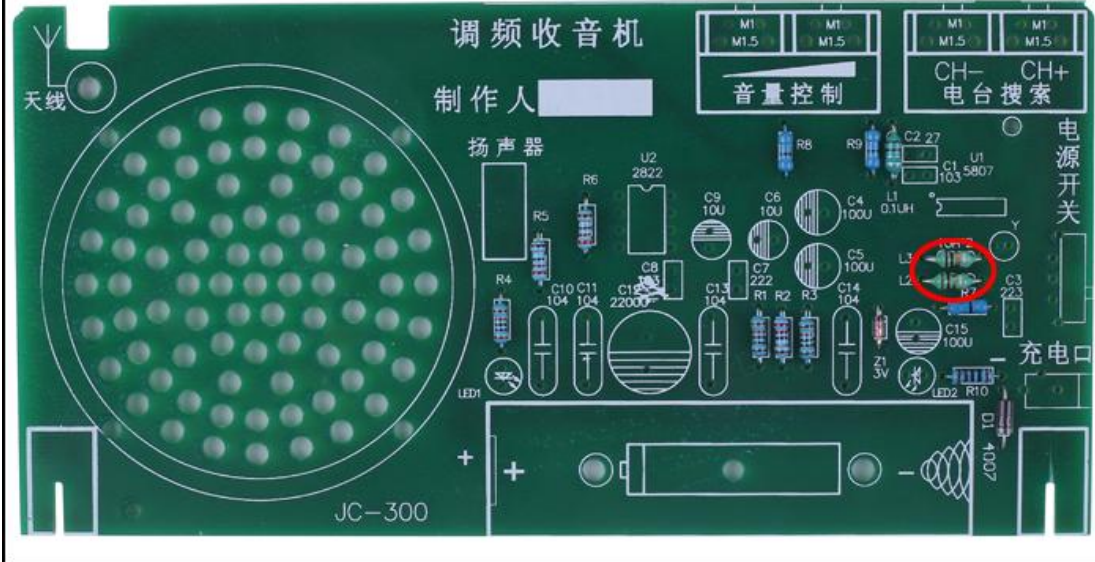

Step 10: Install 1pcs SOP-16 RDA5807 FM Receiver at U1 on **PCB another side**.

There is a dot on one end of the IC and there is a dot on PCB where the IC can place on. These two marks are corresponding to each other and are used to specify the installation direction of the IC.

Note: 'SMD IC Installation Method' as showing at last if user if user is not familiar with SMD chip installation

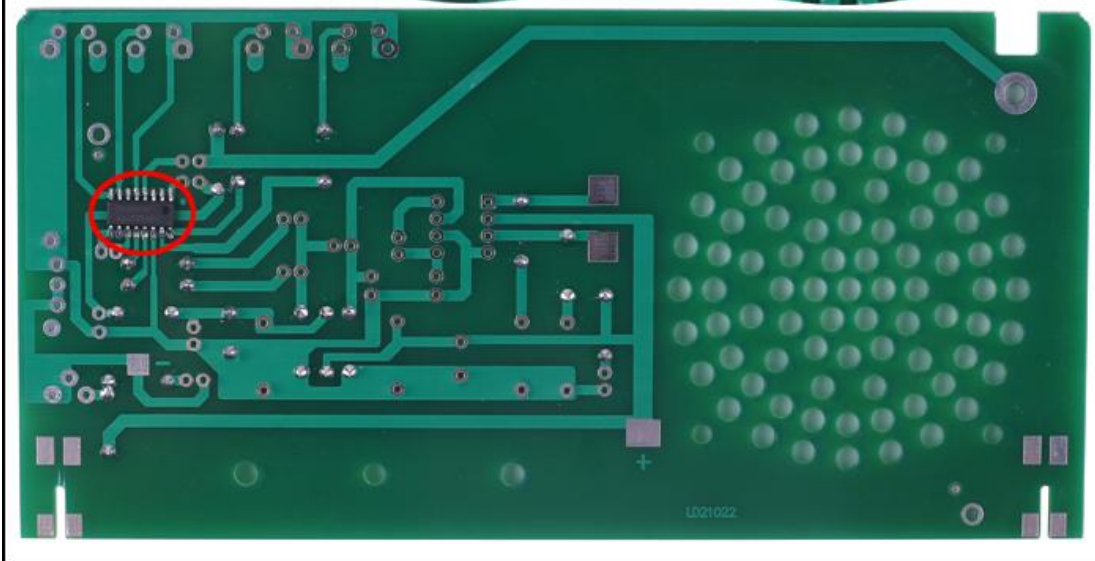
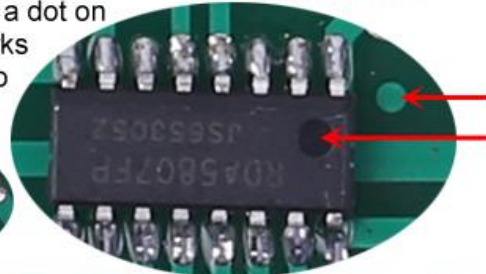

Step 13: Install 1pcs 27pF Ceramic Capacitor at C2.

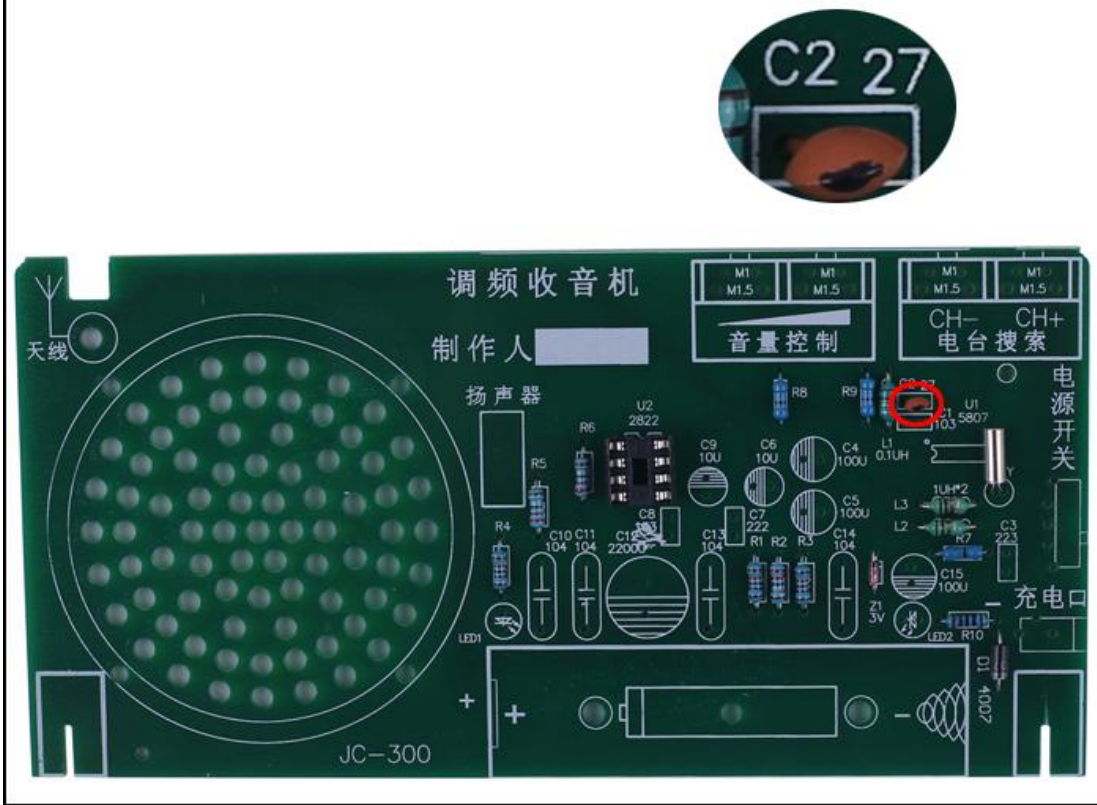

Step 14: Install 2pcs 0.01uF 103 Ceramic Capacitor at C1,C8.

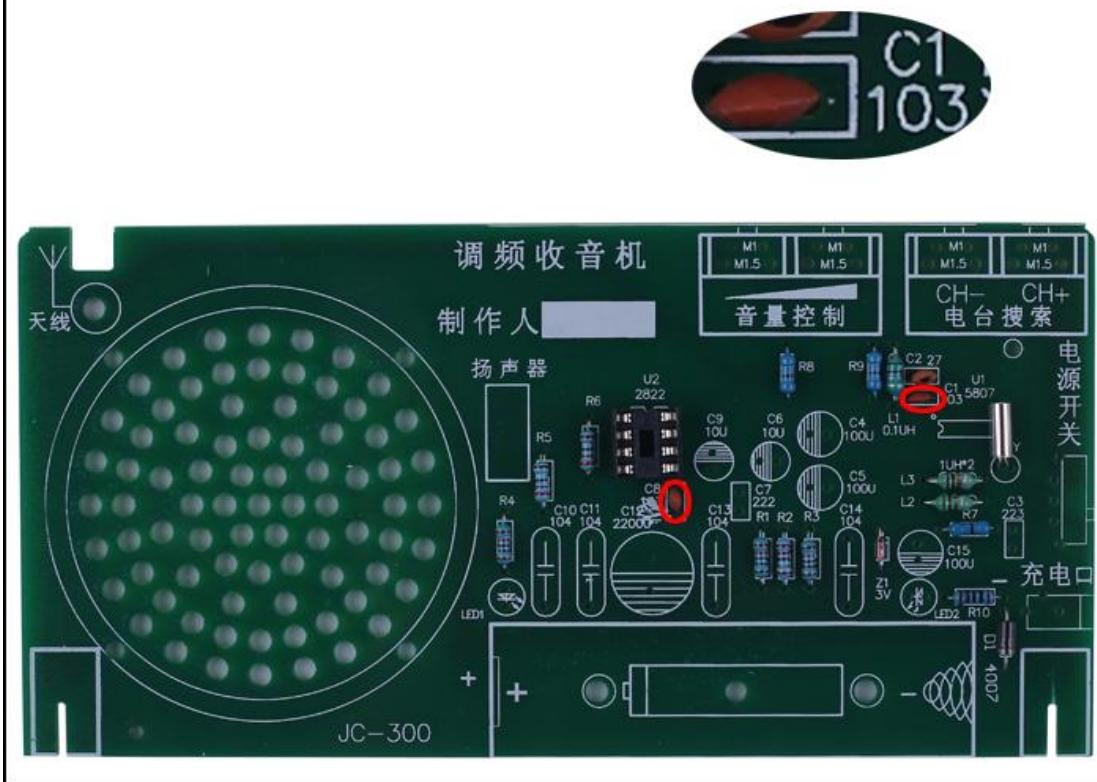

Step 15: Install 1pcs 2.2nF 222 Ceramic Capacitor at C7.

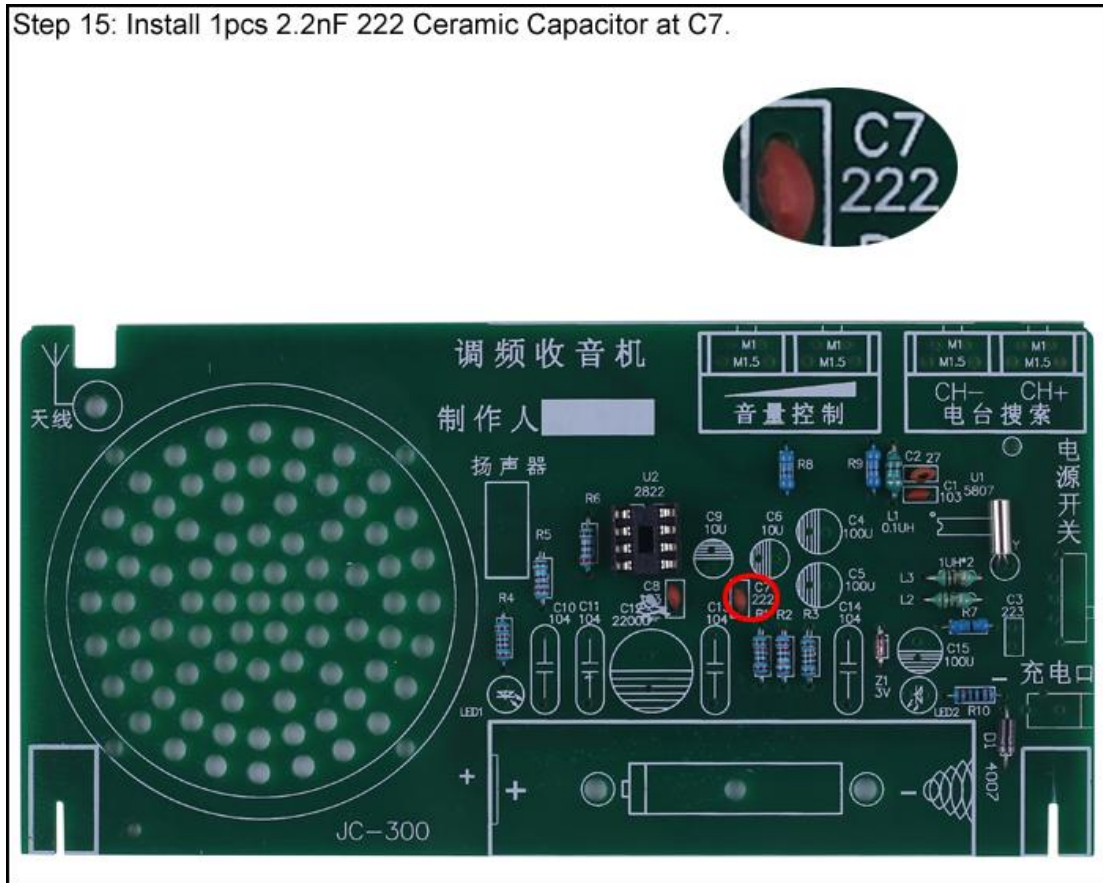

Step 16: Install 1pcs 22nF 223 Ceramic Capacitor at C3.

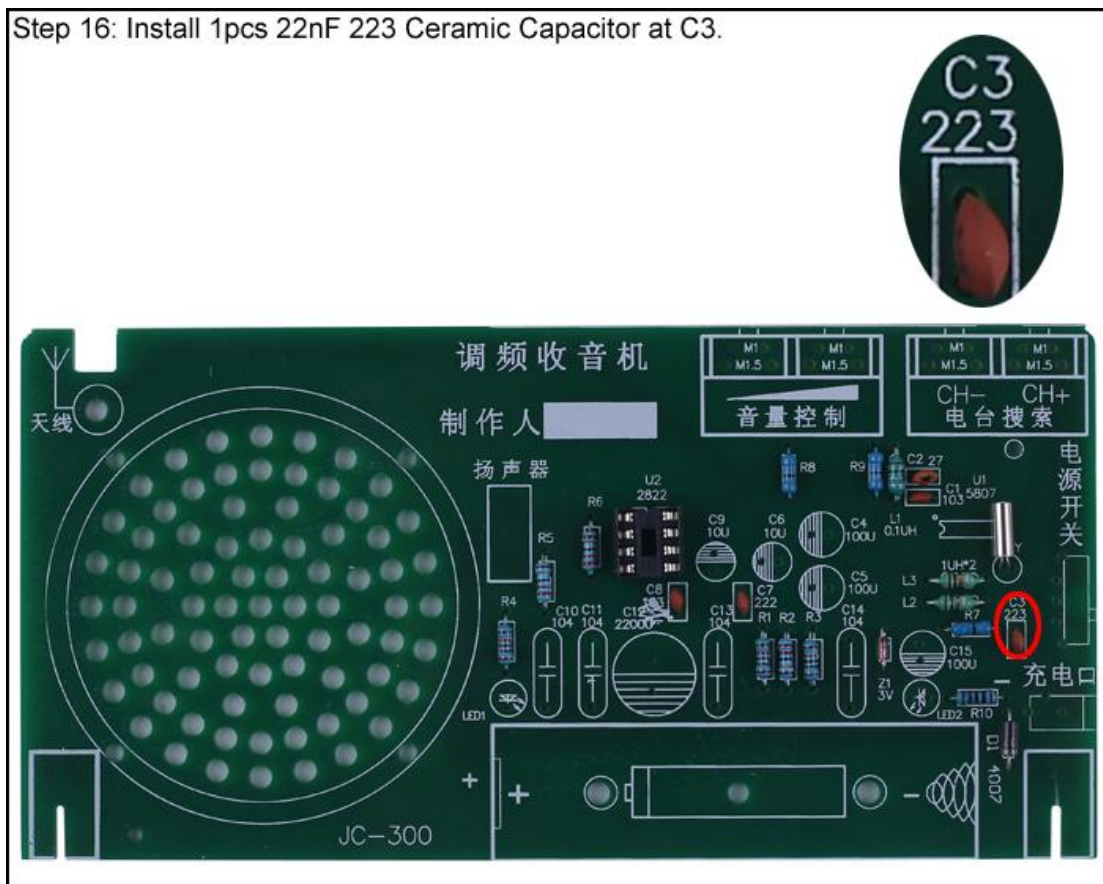

Step 17: Install 2pcs 3mm Red LED at LED1,LED2. Pay attention to the installation direction. The shorter pin is negative pole.

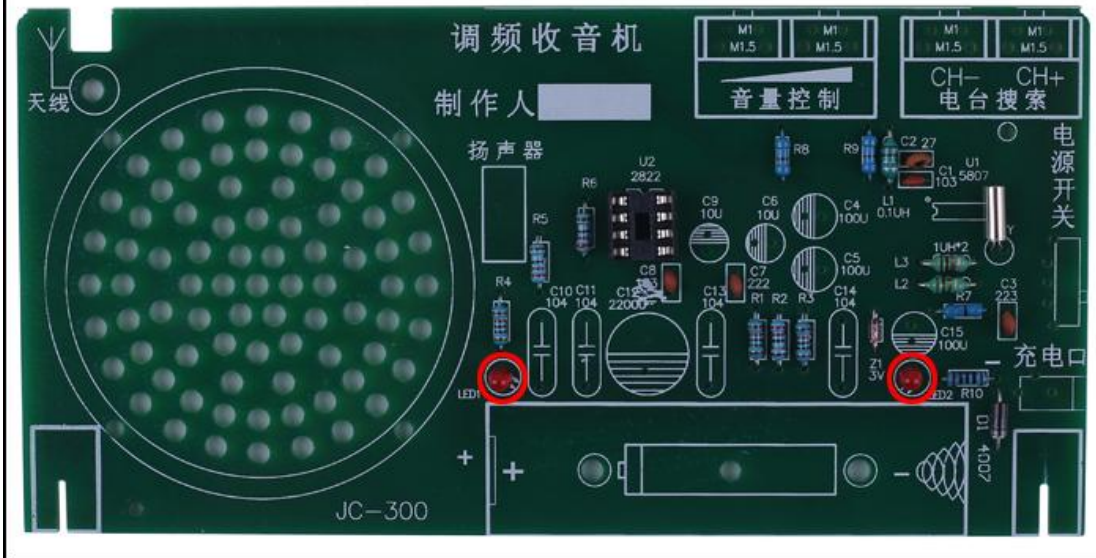

Step 18: Install 2pcs 10uF Electrolytic Capacitor at C6,C9. Pay attention to distinguish between positive and negative. The shorter pin is negative pole.

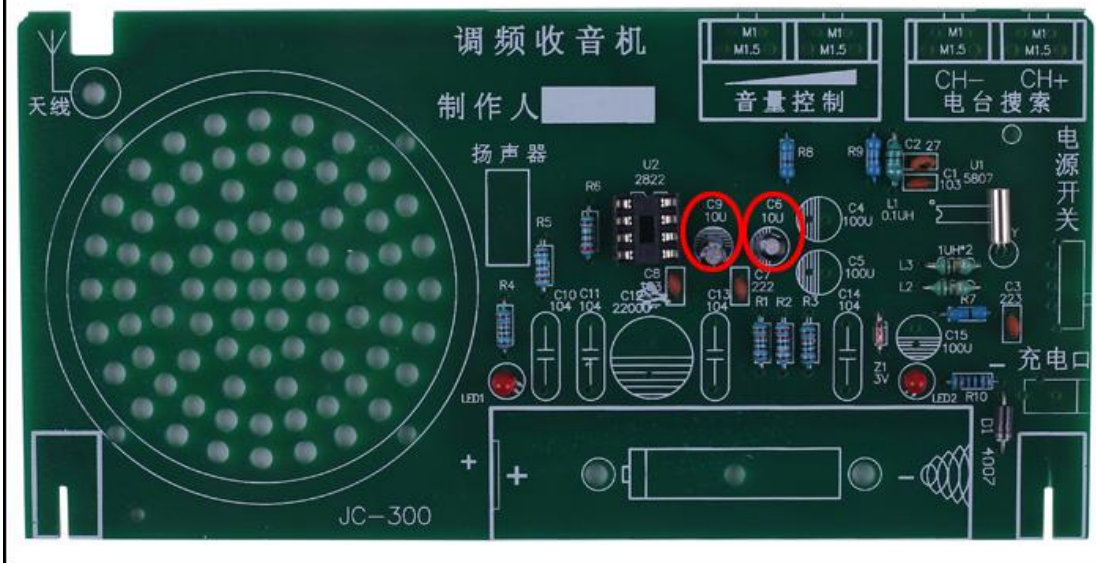

Step 19: Install 3pcs 100uF Electrolytic Capacitor at C4,C5,C15. Pay attention to distinguish between positive and negative. The shorter pin is negative pole.

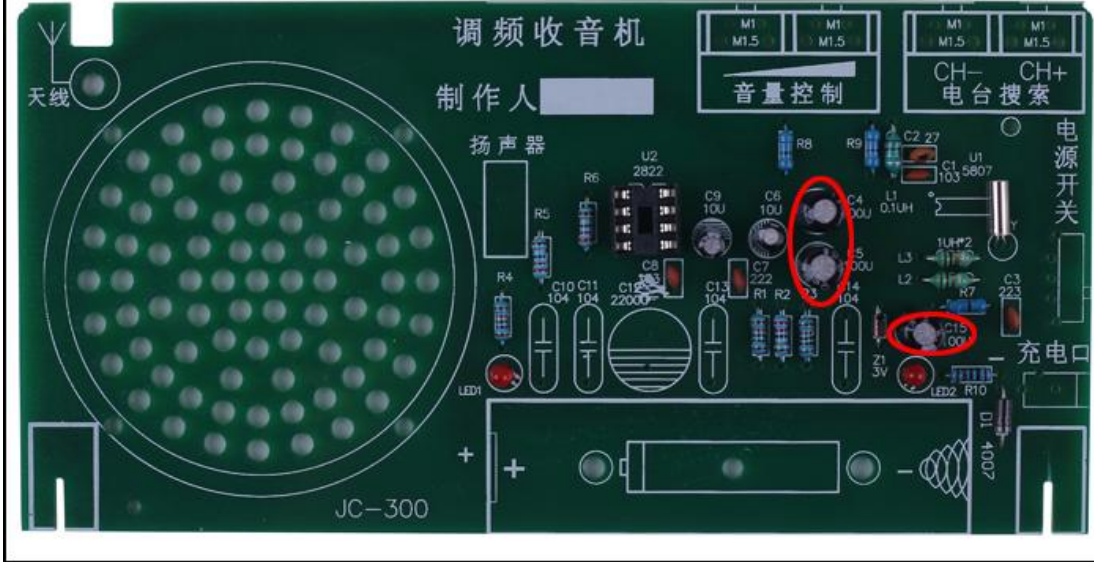

Step 20: Install 4pcs 0.1uF 104 CBB Capacitor at C10,C11,C13,C14.

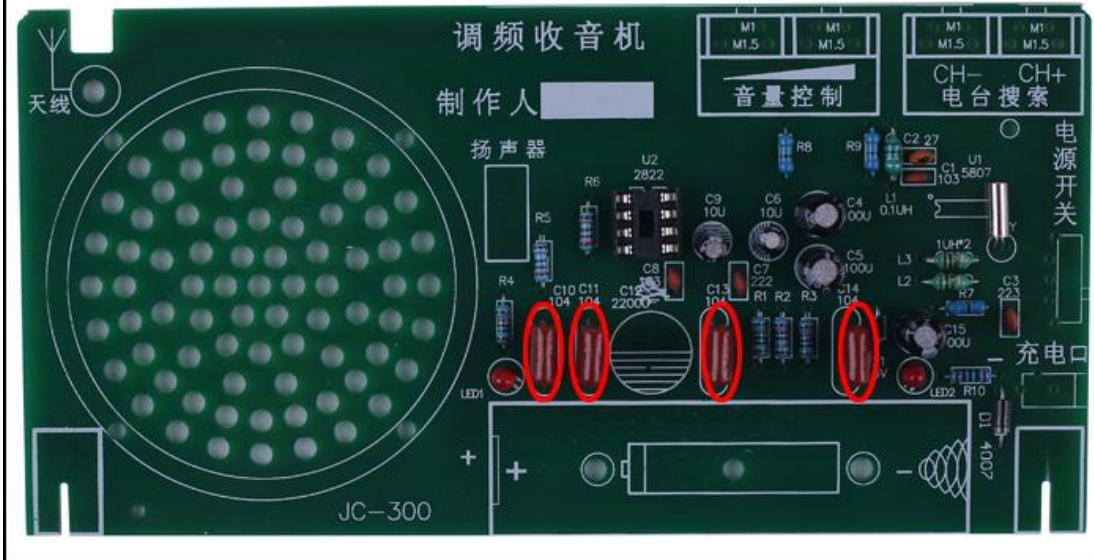

Step 21: Install 1pcs 2200uF Electrolytic Capacitor at C12. Pay attention to distinguish between positive and negative. The shorter pin is negative pole.

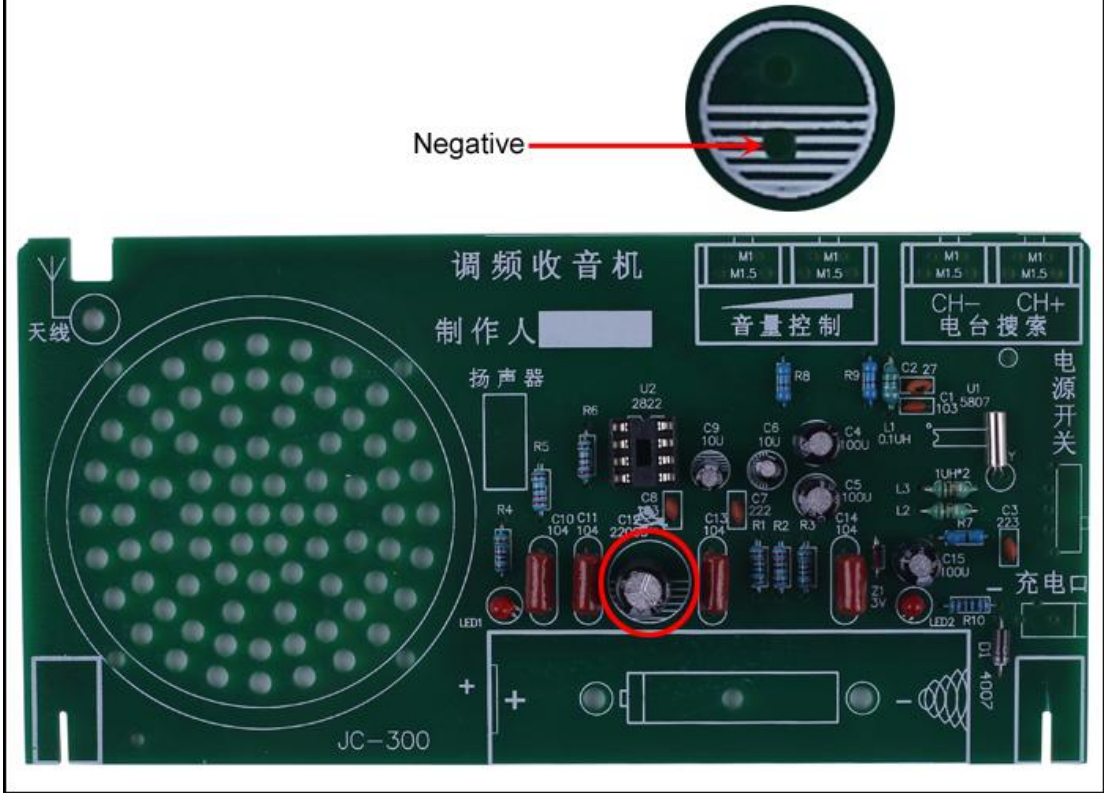

Step 22: Install 1pcs Power Socket at J1.

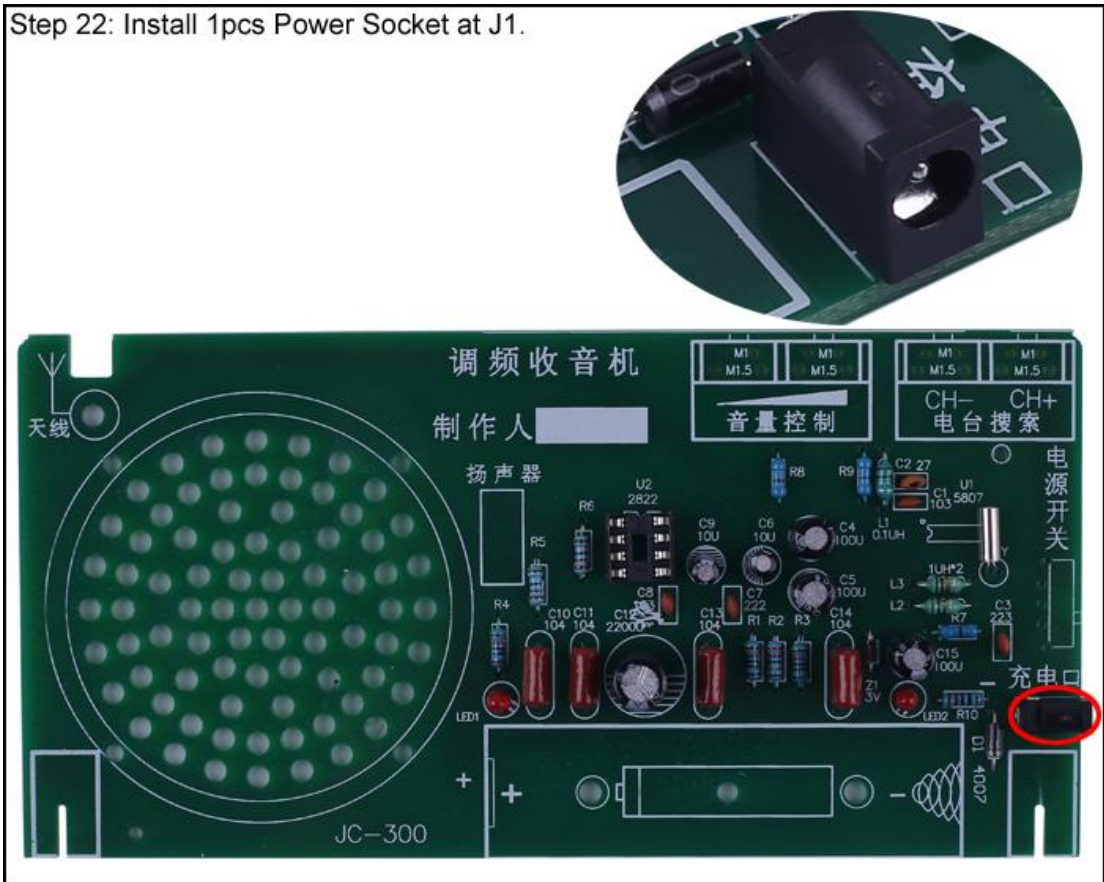

Step 23: Install 1pcs Power Switch at K1.

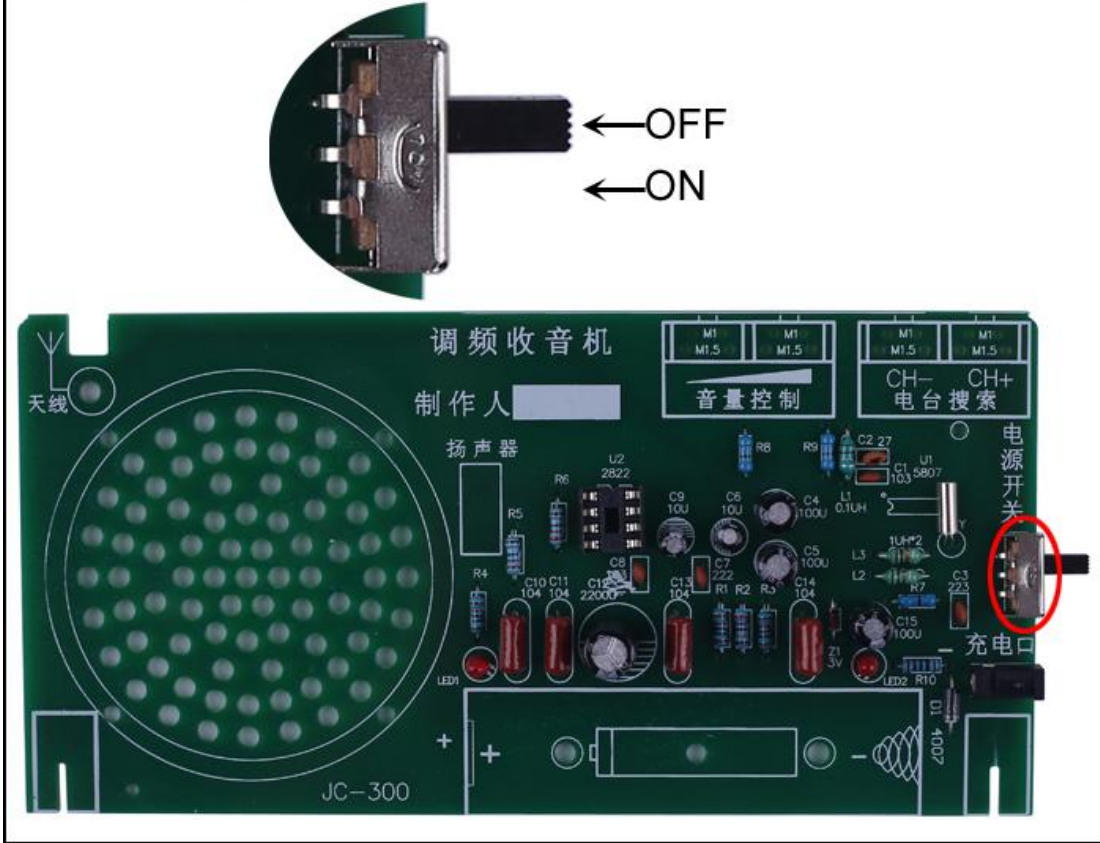

Step 24: Install 4pcs Black Button at S1-S4.

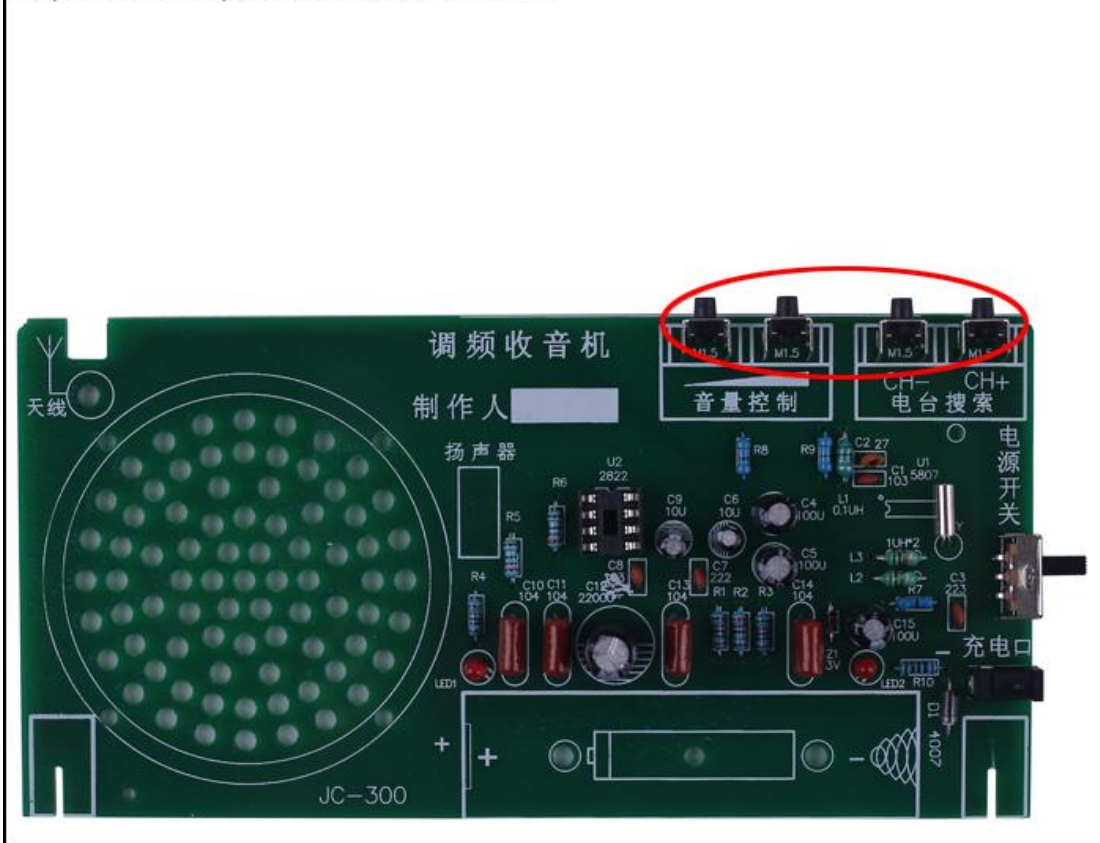

Step 25: Install 1pcs DIP-8 IC TDA2822 Amplifier at U2. There is a mark(notch) on one end of the IC Socket and there is a mark(curved silk screen printing) on PCB where the IC can place on. These two marks are corresponding to each other and are used to specify the installation direction of the IC.

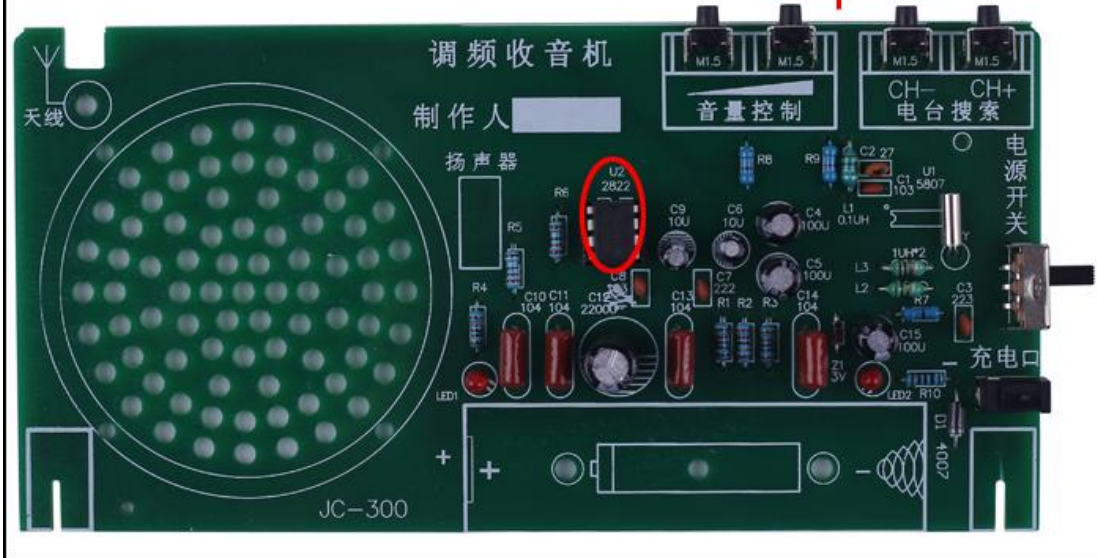
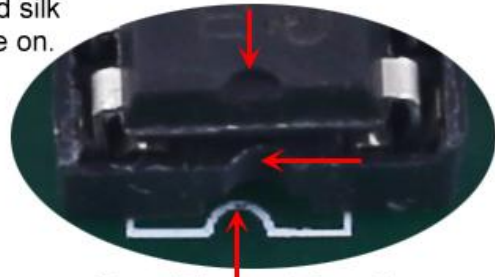

Step 26: Fix Speaker on PCB another side by 4pcs M2*10mm Screw and 4pcs M2 Nut.

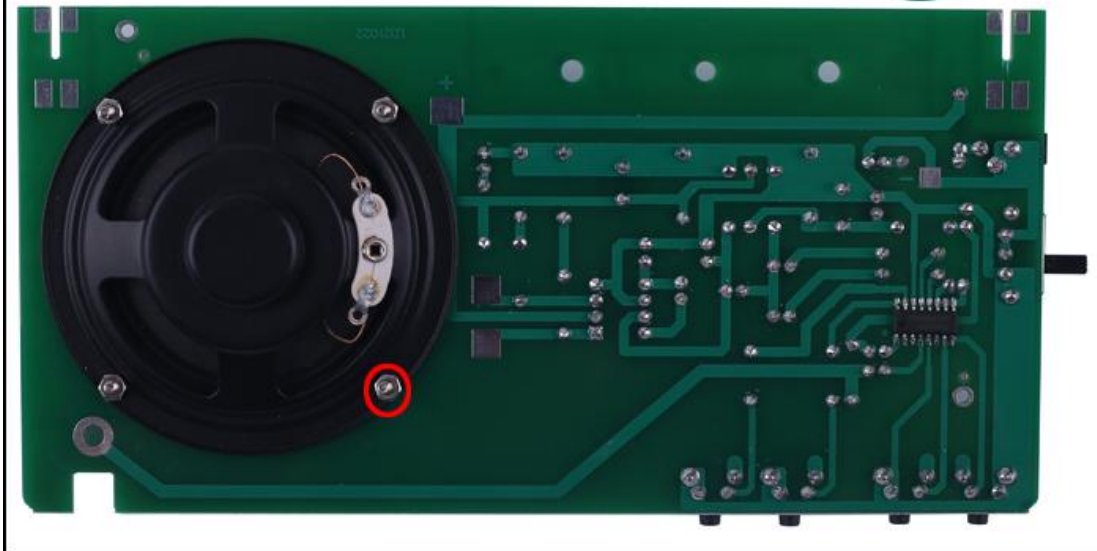

Step 27: Connect speaker to PCB by red/black wires.

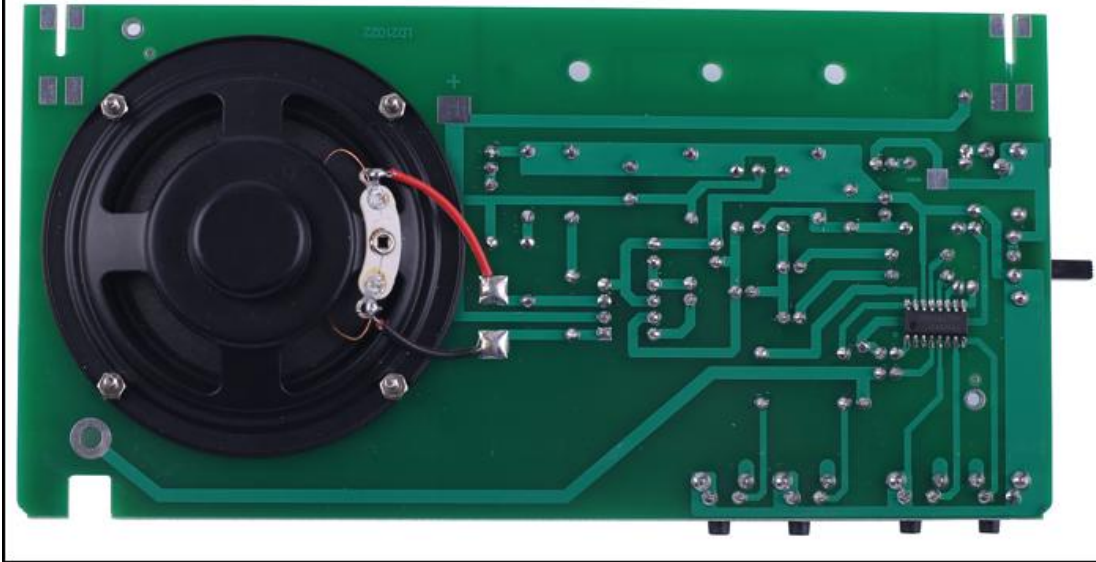

Step 28: Fix 18650 battery box by 1pcs M3*6mm Screw and 1pcs M3 Nut. Pay attention to the installation direction.

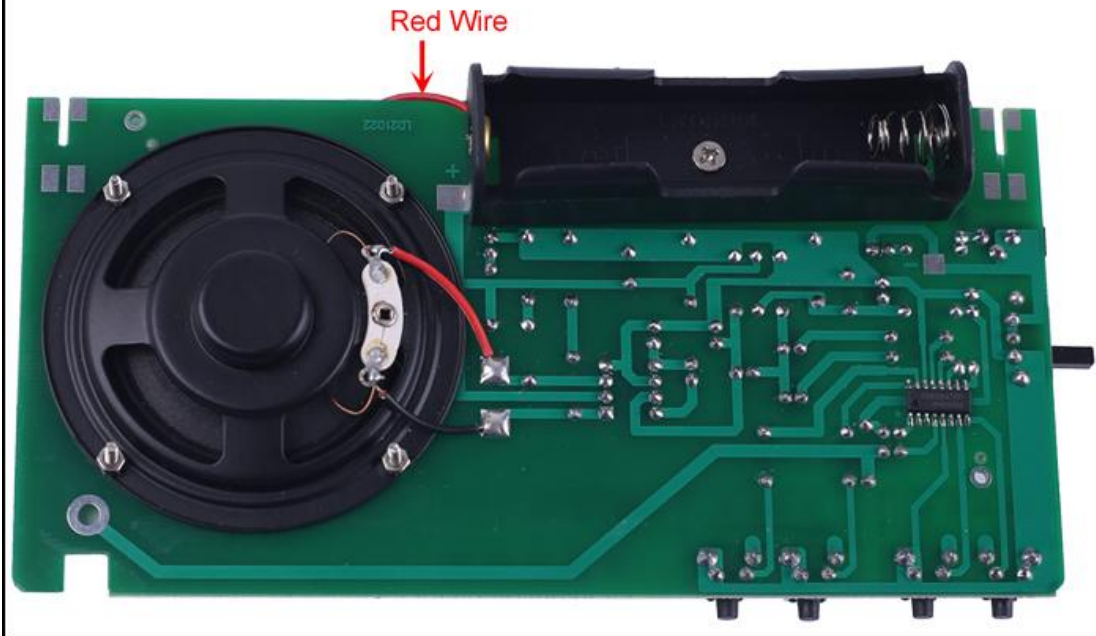

Step 29: Connect battery wire to PCB: Red connect to '+' and black connect to '-'.

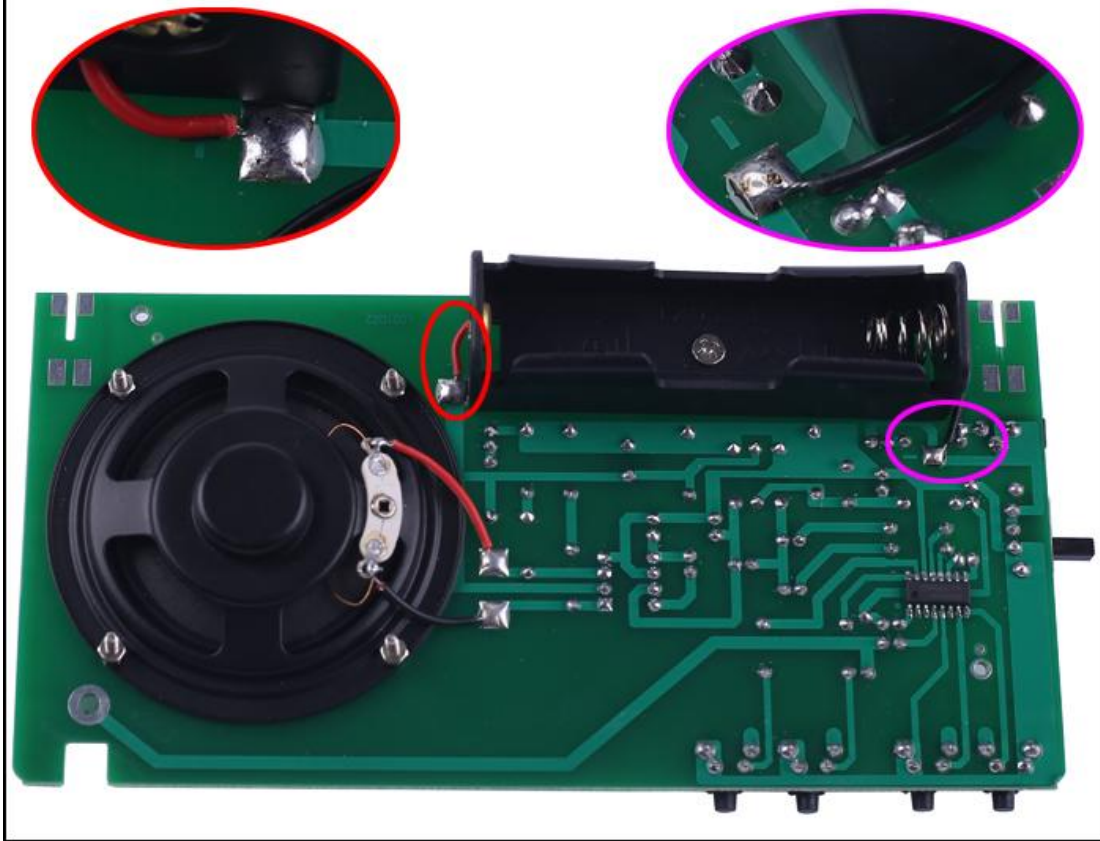

Step 30: Fix 1pcs FM Antenna by 1pcs M3*6mm Screw.

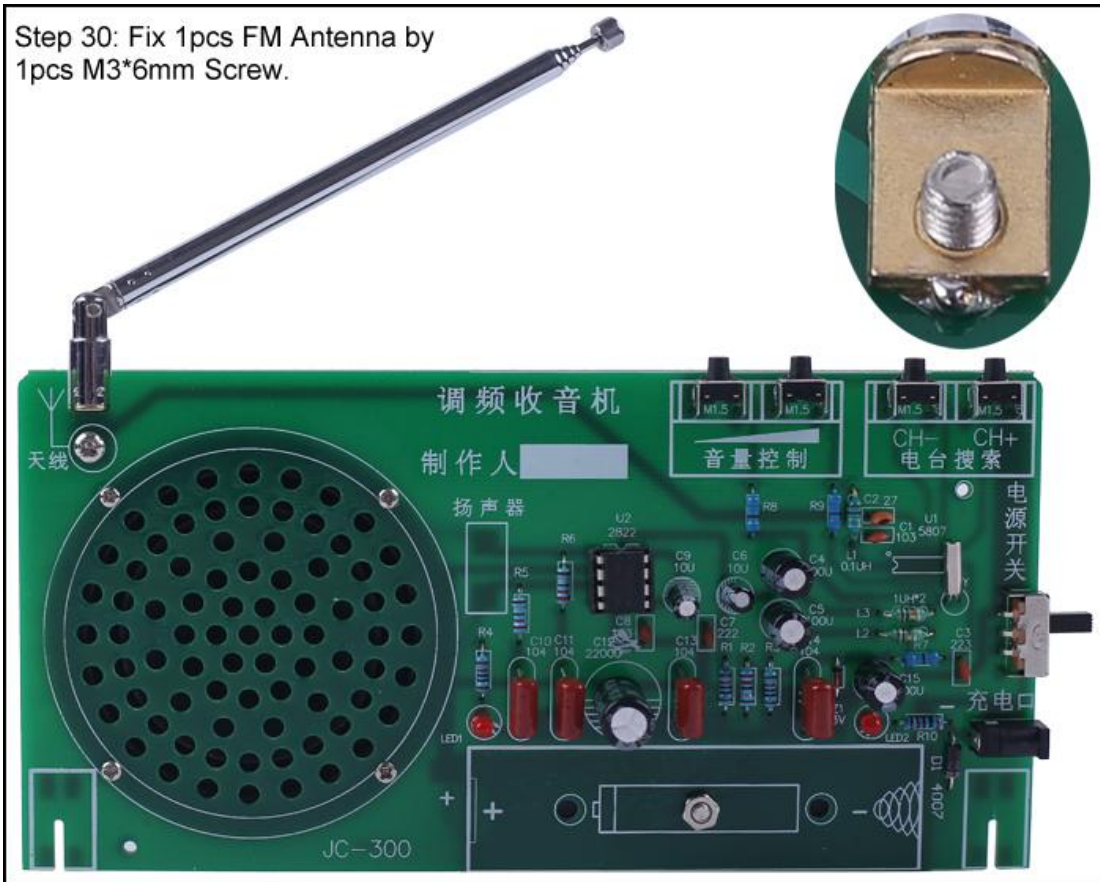

Step 31: Fix 2pcs PCB Bracket. Note that the pads must be aligned.

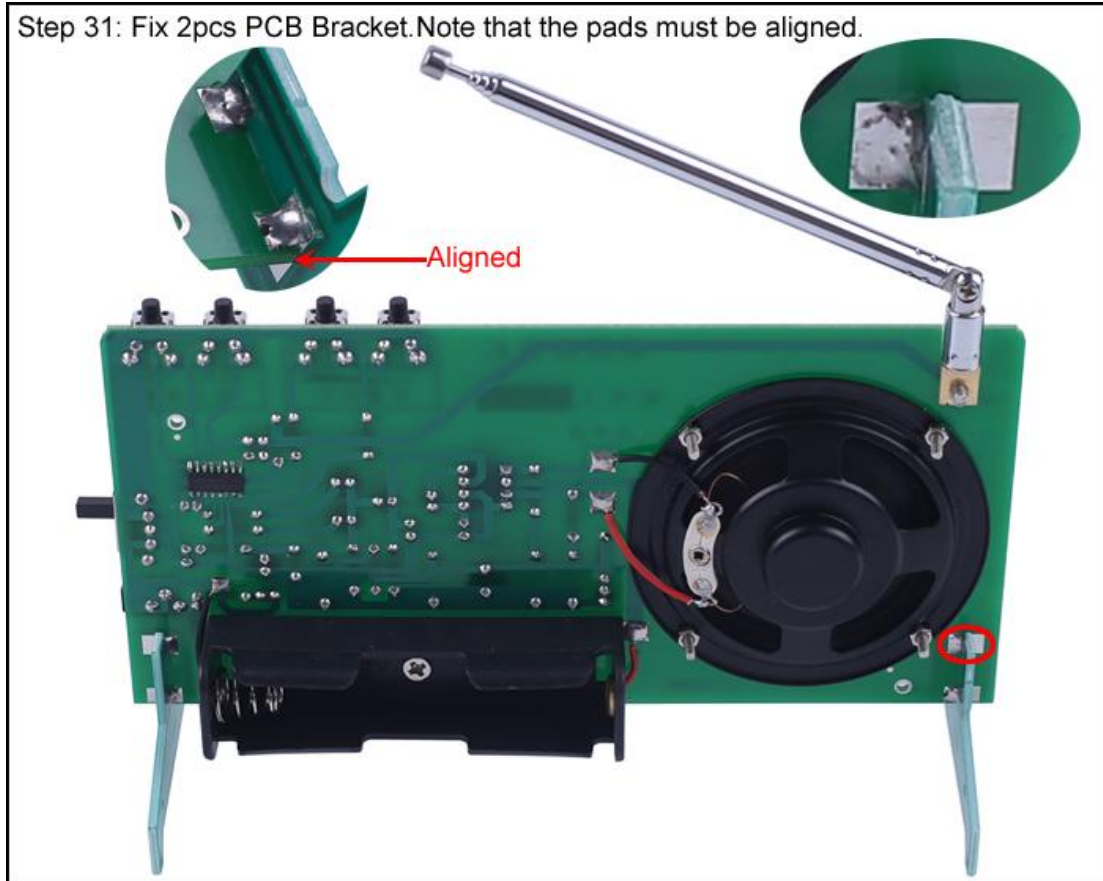

Step 32: Install 1pcs 3.7V 18650 battery(not included) then to receiver FM stations.

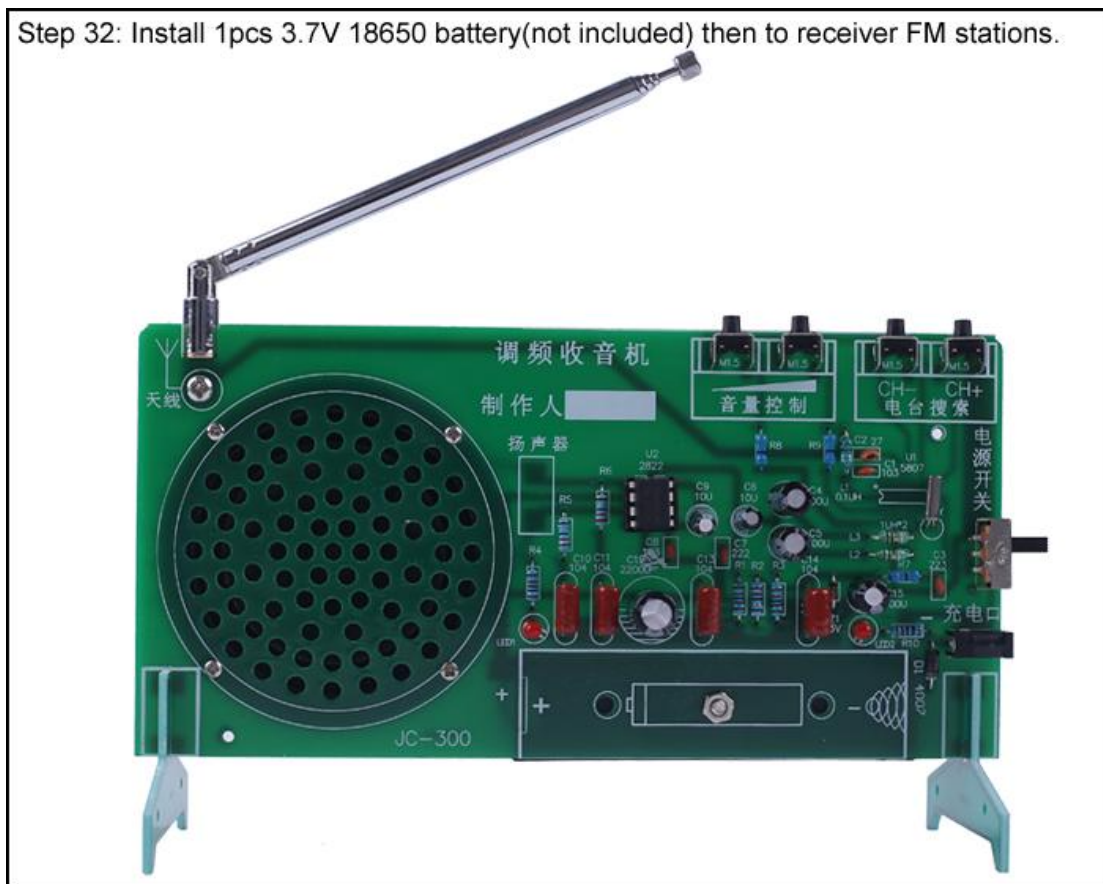

11.SMD IC Installation Method:

1>.Step 1: Melt a small amount of solder on the pad which IC can placed(It is used for positioning the chip in the next step).

2>.Step 2: Hold the chip with tweezers and adjust the position so that the pins of the chip coincide with all the pads and are close to the pads.Pay attention to the mounting direction of the chip.

3>.Step 3: Use a soldering iron to melt the solder just now so that the chip can be fixed.At this time, the tweezers are still holding the chip and keep calibrating the position.

4>.Step 4: Melt a lot of solder on top of another row of chip pins.Make sure there is enough solder between each pin and the pad.

5>.Step 5: Using a solder sucker to suck out excess solder. While heating with a soldering iron, suck out excess solder. Tips: First find a suitable place to place the tin remover, and then use a soldering iron to melt the solder.

6>.Step 6: Check whether enough pads are filled between each pin and pad. Otherwise, you need to add more solder.

7>.Step 7: In the same way, install another row of pins.

8>.Note:This is an installation method of the SMD chip, and user can also use other installation methods.

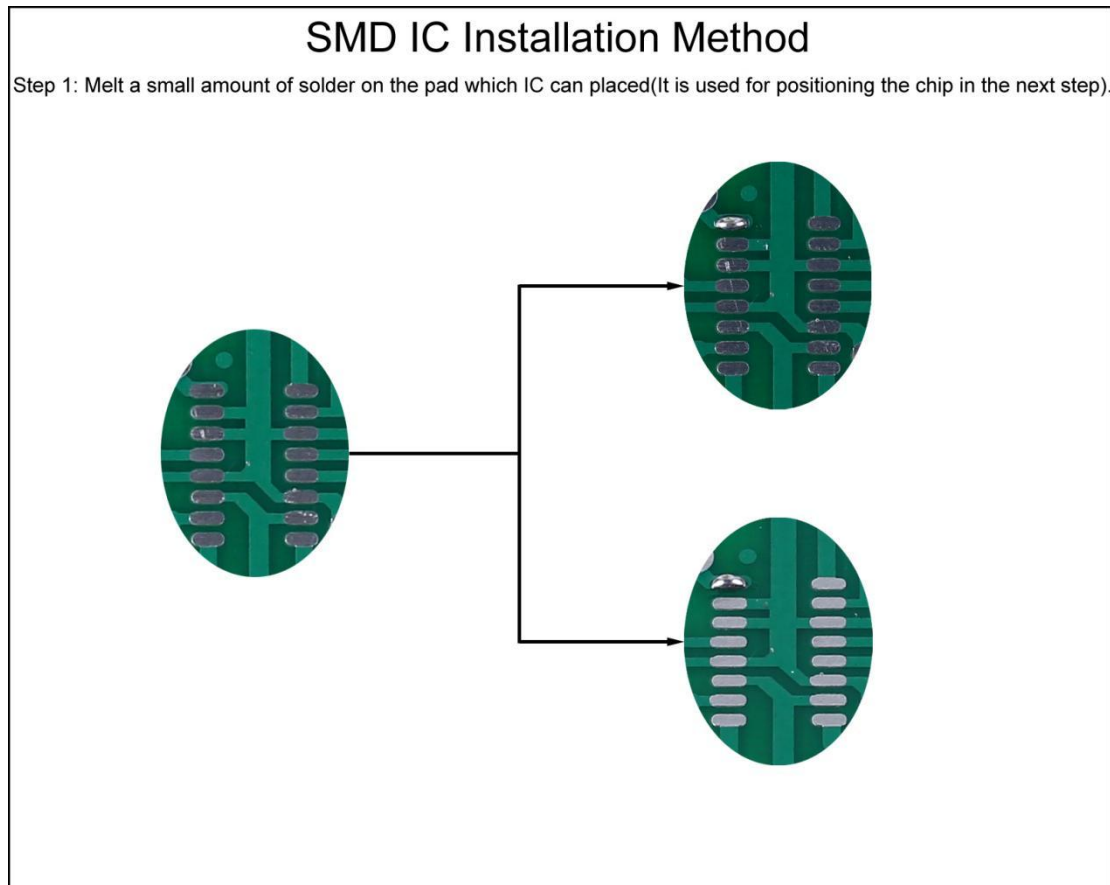

SMD IC Installation Method

Step 2: Hold the chip with tweezers and adjust the position so that the pins of the chip coincide with all the pads and are close to the pads. Pay attention to the mounting direction of the chip.

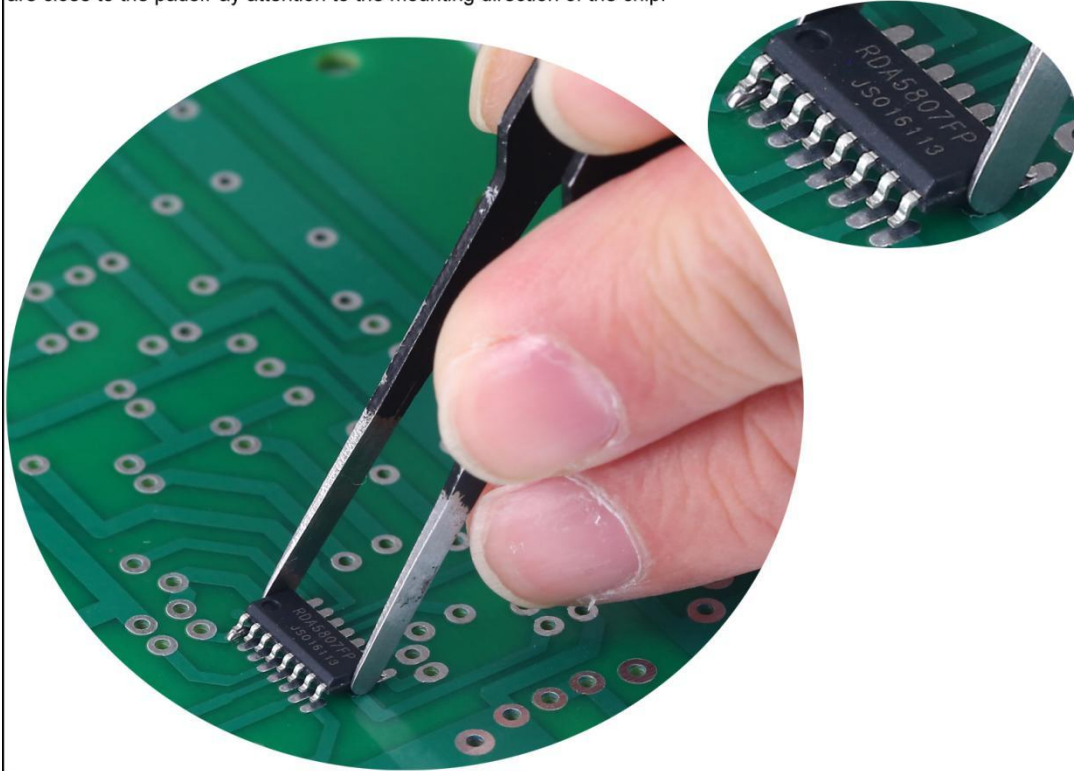

SMD IC Installation Method

Step 3: Use a soldering iron to melt the solder just now so that the chip can be fixed. At this time, the tweezers are still holding the chip and keep calibrating the position.

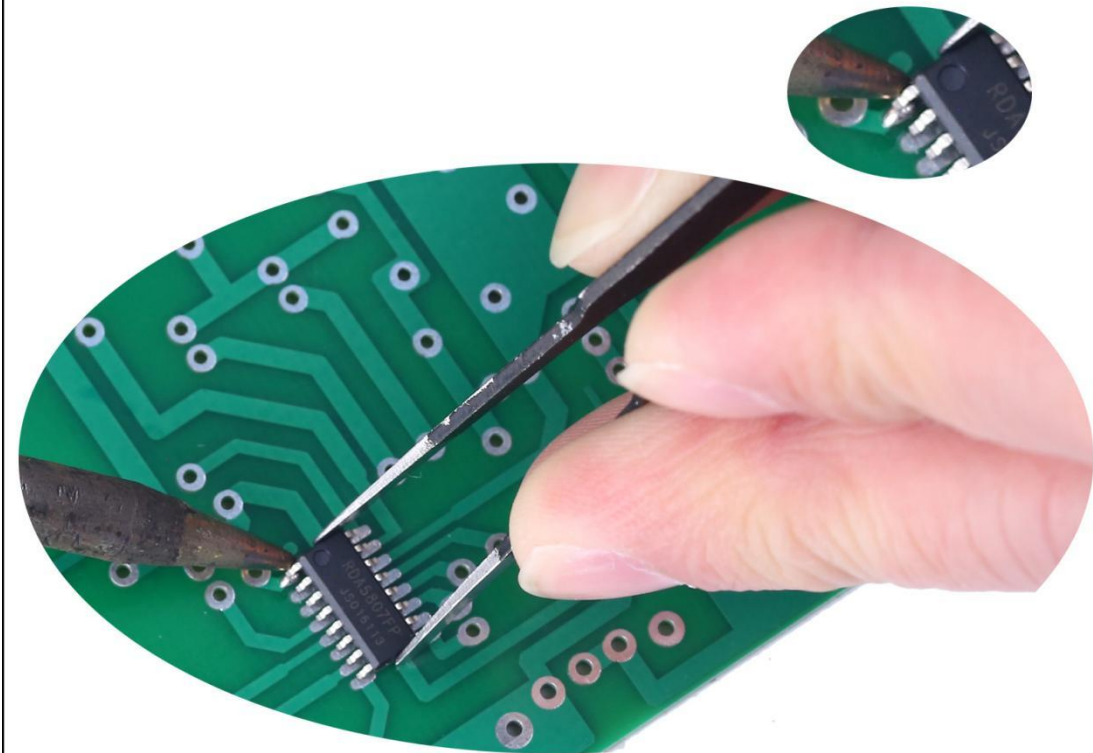

SMD IC Installation Method

Step 4: Melt a lot of solder on top of another row of chip pins. Make sure there is enough solder between each pin and the pad.

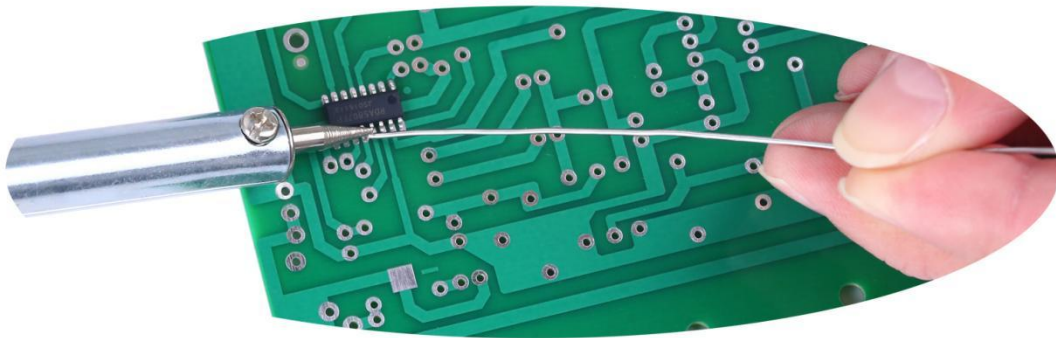
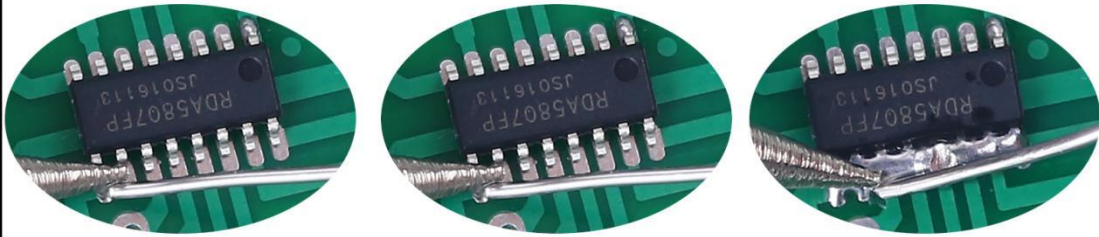

SMD IC Installation Method

Step 5: Using a solder sucker to suck out excess solder. While heating with a soldering iron, suck out excess solder. Tips: First find a suitable place to place the tin remover, and then use a soldering iron to melt the solder.

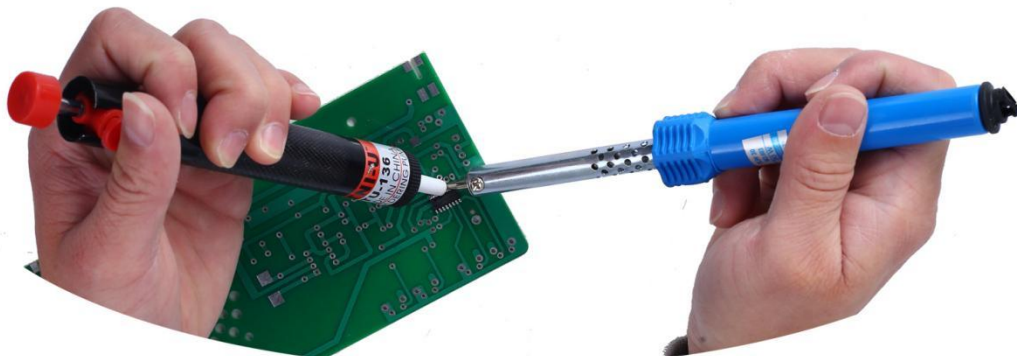
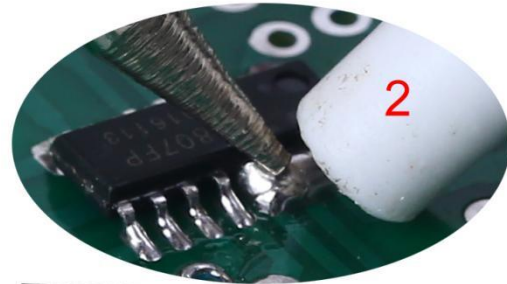
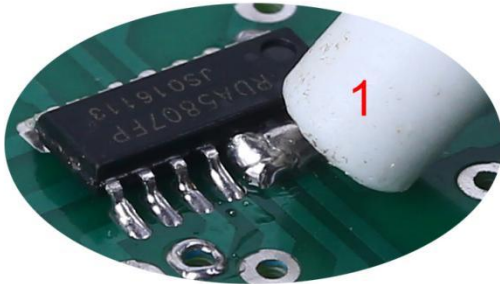

SMD IC Installation Method

Step 6: Check whether enough pads are filled between each pin and pad. Otherwise, you need to add more solder.

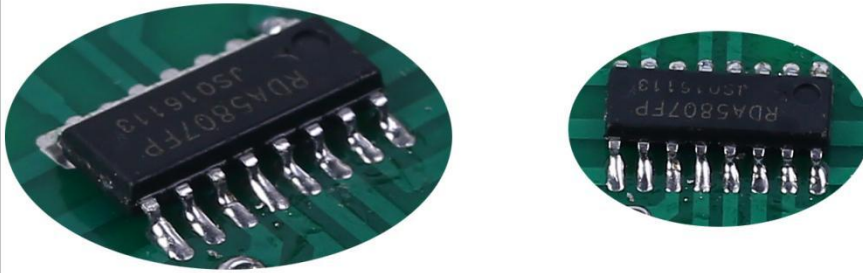

Step 7: In the same way, install another row of pins.

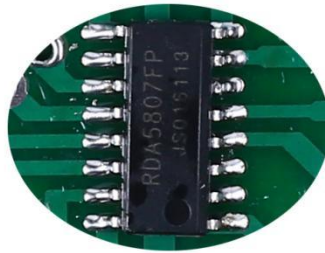

Note: This is an installation method of the SMD chip, and user can also use other installation methods.